

USER'S MANUAL



Planet Audio®

P9690B

BLUETOOTH® ENABLED

**IN-DASH SINGLE-DIN DVD/MP3/CD AM/FM RECEIVER
3.2" (81MM) WIDESCREEN TOUCHSCREEN TFT MONITOR
with USB and SD Memory Card Ports and Front AUX Input**



Planet Audio®

www.planetaudiousa.com

TELEPHONE
888.990.1236
805.988.0215

FAX
805.988.0275

TECHNICAL SUPPORT
www.planetaudiousa.com/support

P9690B 0313

all specifications subject to change without notice
© Planet Audio

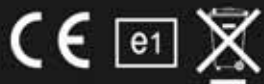

**To ensure safety while driving
and to comply with laws,
drivers should not watch video or
operate the video device while driving.**

7. Specification

General Specification

Power Supply Requirement.....DC 12V
Maximum Power Output.....4 x 80W(measured at DC 14.4V)
Dimensions(w x h x d).....7"W x 2"H x 6.5"D

DVD Deck Specification

Format.....DVD/VCD/MP4/JPEG//MP3/WMA/CD
Video System.....NTSC
Audio System.....24 bit/96KHz
Loading System.....Auto Loading
Mounting Angle.....0 to +/-30

Video Specification

Video Type.....16:9 and 4:3
Video Output level.....Composite: 1.0•• 0.2Vp-p
Load impedance: 75ohms
Horizontal Resolution.....500

Audio Specification

Audio Output(Analog audio).....2.0⁺⁰-1.0Vrms
Frequency Response.....20Hz ~ 20KHz(at 1KHz 0 dB)
S/N Ratio(Audio).....•• 90dB(at 1KHz 0 dB)
Separation.....50dB

Radio Specification

FM Section
Frequency range.....87.5MHz - 107.9MHz(US)
87.5MHz - 108.0MHz(EU)
Usable sensitivity.....3uV
I.F Frequency.....10.7MHz

AM Section
Frequency.....530KHz - 1710KHz(US)
522KHz - 1620KHz(EU)

6. Trouble Shooting

Please read the user manual carefully before using the DVD player. If you have any trouble in using this player, try to troubleshoot by using the recommended suggestions mentioned below. If you are still having difficulty, please contact the company or the technical service center authorized by us. For your safety, do not open the cover and attempt to repair the player by yourself, if that. It will cause electrical shock and harm.

NO PICTURE, SOUND AND INDICATION

- * Ensure that the power switch is on.
- * Ensure that the power cable is not damaged or the fuse is not blown.
- * Ensure that the power is connected properly.

NO SOUND BUT PICTURE OK

- * Ensure that the player audio output has a good connection with the TV audio input.
- * Check whether the audio connector is damaged.
- * Check whether you have turned down the volume.
- * Ensure that you have set the right AUDIO setup of the player.
- * Ensure that the audio is not under mute.

NO PICTURE BUT SOUND OK

- * Ensure that the player video output has a good connection with the TV video input.
- * Ensure that you have turned your TV to the AV input channel connecting to your player.
- * Check whether the video connector is damaged.
- * Ensure that you have set the right VIDEO settings of the player.

BLACK AND WHITE PICTURE OR SCREEN ROLLING

- * Ensure that you have set the right TV SYSTEM (e.g. PAL, NTSC) setting.

FLAWS OF PICTURE OR SOUND

- * Check whether the AUDIO setting is right.
- * Check whether the disc is scratched or stained.
- * Check whether the AV connector and the output terminal is stained.
- * Check whether there is condensation inside the lens. If so, leave the player off for an hour or so, then try again.
- * Check whether the installation angle is less than 30°.

DISPLAY NO DISC OR BAD DISC

- * Ensure that you have put the disc on the tray.
- * Check whether the disc is put in the reverse side.
- * Check whether the disc is distorted.
- * Check whether the disc is stained or scratched badly.
- * Ensure that the disc format is compatible to the player.
- * Ensure that the temperature inside the car is not too high. If so, cool off until the ambient temperature returns to normal.
- * Replace another disc to insert it into the disc compartment.

REMOTE CONTROL HAS POOR RESPONSE RANGE OR DOES NOT WORK

- * Check the batteries of remote control and make sure that they are not flat.
- * Direct the remote control to the IR sensor of the player.
- * Check whether there are some obstacles between the remote control and IR sensor.

SOME FUNCTION BUTTONS DO NOT WORK

- * Turn off the power, then turn on again.
- * Reset the unit to zero, then turn on again.
- * Remove the front panel from the unit, then install it again and then turn on again.

THE RADIO DOES NOT WORK

- * Check whether the antenna cable is connected firmly. Or manually tune for a station.

PRECAUTION



CAUTION: TO REDUCE THE RISK OF ELECTRIC SHOCK, DO NOT REMOVE COVER (OR BACK). NO USER SERVICEABLE PARTS INSIDE. REFER SERVICING TO QUALIFIED SERVICE PERSONNEL.



The lightning flash with arrowhead symbol, within an equilateral triangle, is intended to alert the user to the presence of uninsulated dangerous voltage within the product's enclosure that may be of sufficient magnitude to constitute a risk of electric shock to persons.



The exclamation point within an equilateral triangle is intended to alert the user to the presence of important operating and maintenance (servicing) instructions in the literature accompanying the appliance.

CLASS 1 LASER PRODUCT

Laser product symbol: located on the rear panel of the unit, indicate this player is a class laser product, only use weak laser and no hazardous radiation outside of the unit.

1. Read through this instruction manual before installation and use.
2. Do not open the cover or touch any of the components exposed out of the unit, only for qualified technicians.
3. Do not expose the unit under direct sunlight or nearby objects that radiate heat to avoid damage the unit.
4. Do not place the unit in moist and humid conditions, which effect the pick-up of the unit lead to out of work.
5. Place the unit on a flat surface and ventilative condition. Please ensure the ventilation holes are not covered to avoid overheating and malfunction.
6. Clear the panel and case with soft dry cloth only, do not apply any kind of thinner, alcohol or sprays.

Contents

1. Before Operation.....	4
1.1 Glossary.....	4
1.2 Precautions.....	4
1.3 Maintenance and Cleaning of Discs.....	5
1.4 Battery Information of the Remote Control.....	5
1.5 The Remote Control Description.....	6
1.6 Locations and Names of the Controls.....	7
1.7 Description of the Rear Cabinet.....	8
1.8 Unit Installation.....	9
2. Common Operation.....	10
3. Radio Operation.....	12
4. Basic Disc, USB or SD Operation.....	14
4.1 Begin Playback.....	14
4.2 Pause Playback.....	15
4.3 Stop Playback.....	15
4.4 Select Chapter/Track with the UP/DN or the >> / << Buttons.....	15
4.5 Select Chapter/Track with the Number Buttons.....	16
4.6 Select Chapter/Track with the Root/PBC Menu.....	16
4.7 Terminate the Playback.....	16
4.8 Playback with Speed.....	17
4.9 Playback with Slow Speed.....	17
4.10 Playback with Still Frame.....	17
4.11 Playback Repeatedly.....	17
4.11.1 One/All Repeat.....	17
4.11.2 A-B Repeat.....	18
4.12 Playback in Scan Mode.....	18
4.13 Playback from a specified Chapter/Track or a Specified Time.....	18
4.14 Playback in Random.....	19
4.15 Playback in Different Angle.....	19
4.16 Playback in Zoom Mode.....	19
4.17 Change the Caption Language.....	19
4.18 Change the Audio Language.....	19
4.19 Program Playback.....	20
4.20 Playback the Picture CD in JPEG Format.....	20
4.21 Operation about file style of video.....	21
4.22 ESP and ID3 Function.....	21
4.23 USB and SD Reader Operation.....	21
4.24 The DVD System Menu Setup Operation.....	22
4.25 The Parental Control.....	26
5. Bluetooth Handfree System(Optional).....	27
6. Trouble Shooting.....	29
7. Specifications.....	30

4.3 To redial the last phone number dialled

- (1) Short press TEL button . It will show a line on the display.
- (2) Short press REDIAL button, It will dial the last phone number.

5. Accept/Reject/End Call

5.1 When ringing, short press TEL button to accept the call

5.2 When ringing, short press HANG UP button to reject the call

5.3 When talking, short press HANG UP button to end the call

Note: During ringing, the phone number appears.

6. Dialling or receiving call during sleep mode

When the car audio is on sleep mode (Acc on and standby), to call out (with mobile phone) or receive a call, the car audio will temporarily power on.

7. To transfer the audio of a file played by Mobile Phone to the Car Audio Player

In the connection status between the Bluetooth devices of the Car Audio Player and a Mobile Phone, if the mobile phone can play audio files and support A2DP, when the Mobile Phone plays an audio file (For some Mobile Phones, you must select Play by BT first), the audio of the playing file will be transferred to the Car Audio Player.

In A2DP mode, if the Bluetooth device of the Mobile Phone support AVRCP, the functions of the >>|, |<<, PLAY/PAUSE, EJECT, MUTE, EQ, LOUD, VOL and SEL buttons are the same as one in disc mode (no fast forward/backward functions for the >>|/|<< buttons). The other buttons available in disc mode are not available.

5. BLUETOOTH HANDFREE SYSTEM(Option)

1. Pairing and connection

- 1) Turn on the Bluetooth mode of the mobile phone;
 - 2) Select the item of Finding the BLUETOOTH Device and press enter. Once the device and unit are paired, the unit will display the name of the device. Select the device and press enter, and the unit will ask for a password which is 0000. After entering 0000, press enter and after the pairing is complete the unit will display "Pairing is OK".
 - 3) For some mobile phones, they can automatically connect with the BT device of the car audio system after pairing is ok; for some mobile phones, they need to select the paired BT device and press the CONNECTION button . When connection is ok, the LCD of the car audio system will show LINK OK.
- * when pairing is failed, long press the MODE button on the front panel or PAIR button on the remote control to enter pairing mode, then the LCD will display PAIR STAR, then pair and connect with mobile phone again.
- * In Disc mode, press and hold the PAIR button for 3 seconds to enter Pairing mode.

2. Using the mobile phone for connecting and disconnecting.

In the connection status, find the paired and connected Bluetooth Device, then press the disconnection button to disconnect.

In the disconnection status, find the paired and disconnected Bluetooth Device, then press the connection button to connect.

3. In the connection status: Mobile phone transfers to the car audio whenever a dialling takes place; Mobile phone transfers to the car audio whenever receiving a call.

4. Dialling when in connection status

4.1 Dial with the mobile phone directly.

4.2 Dial with remote control with the following procedures:

- (1) Short press TEL button, then a line will appear on LCD.
- (2) Input telephone number with number buttons 0-9
 - * Short press CLEAR button to cancel the wrongly input number if necessary
- (3) Short press TEL to execute the dialling.

1. Before Operation

1.1 Glossary

PBC (playback control)

It is a kind of signal(menu)recorded in the disc with SVCD or VCD2.0 format used for the playback control. For the discs contained PBC, It can playback interactive software with the menu displayed on TV.

Title

Generally, the title is the important part of DVD disc. for example, the theme part of movie is title 1, the part described how to make movie is title 2, the cast is title 3, etc. Every title contain a serial number that is easy to lookup.

Chapter

A title can be divided into several blocks, so that every block can be operated as a unit, the unit is called chapter. The chapter contain a unit at least.

Track

It is the biggest component of VCD. Generally, every song of a disc is a track.

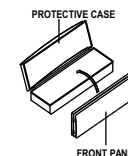

1.2 Precautions

Safety

1. The unit is designed for negative terminal of the battery which is connected to the vehicle metal. Please confirm it before installation.
2. Do not allow the speaker wires to be shorted together when the unit is switched on. Otherwise it may overload or burn out the power amplifier.
3. Do not install the detachable panel before connecting the wire.
4. The protective case is to safely keep the front panel(see the photo).

Environment

1. Do not use this unit when water and moisture is near it.
2. If moisture forms inside the Lens, it may not operate properly. To correct this problem, wait about one hour for the moisture to evaporate.
3. If the car interior is extremely hot, do not use the player until the car has been driven for a while to cool off the interior.

1.3 Maintenance and Cleaning of Discs

Disc Maintenance

1. To keep the disc clean, handle the disc by its edge, do not touch the disc surface of the play side.
2. Do not stick paper or tape on the disc. If there is glue (or analog) on the disc surface, must wipe it up before using.
3. Do not expose the disc to direct sunlight, or nearby heat sources such as caliduct, or leave it in a car parked in direct sunlight where there can be a considerable rise in temperature.
4. Put the disc inside disc case to keep temperature after finishing playback.

Disc Cleaning

1. Before playing, wipe the disc with a clean lint. wipe the disc outwards from the disc center.
2. Do not use petrol, thinner, commercially cleaner or anti-static spray used to plastic LP to wipe disc.

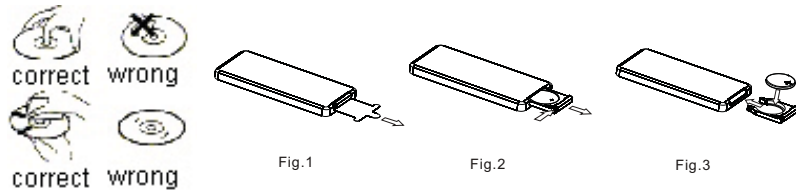

1.4 Battery Information of the Remote Control

Replace Battery in the Remote Control:

1. Before using the remote control for the first time, pull the insulating sheet out of the remote control as the direction indicated by the arrow. (see fig.1)
2. Press the movable block hold as the direction indicated by the A arrow (See fig.2), then pull the battery holder out of the remote control as the direction indicated by the B arrow (see fig.2).
3. Replace the old battery by a new battery with (+) polarity side upward. (See fig.3).
4. Insert the battery holder to the original position in remote control. (See fig.3).

Note about the Battery of the Remote Control:

1. Improper use of battery may cause overheating or explosion. so that Result in injury or fire .
2. Battery leakage may cause damage to the remote control (Battery Life: 6 months with normal use in normal room temperature).
3. Do not short the battery.
4. Do not throw the battery into the fire.
5. To avoid the risk of accident, keep the battery out of reach of children.

4.25 Parental Control

Q: After inserting DVD disc into disc compartment, a dialogue window will appear asking for a password of 4 digits. Why ?

A: This is because the disc movie you are playing was rated with the Parental Control, and the current rating level of DVD player is lower than one of current disc. You must input right password and enter it to entry Parental Control setup menu and then set a equal or higher rating level than one of current disc. So that you can playback the disc.

! NOTE

- * If you have not changed the password, the factory preset password for the DVD player will be empty. So that you should input a desired password and input it again to verify it to enter the Parental Control setup menu.
- * For the rating level setup of Parental Control of the DVD player, please refer to the relative content of LOCK setup menu for details.

Accessories: Parental Control

The Parental Control function of a DVD player can control the playback of movie rated level in a disc. You can set the DVD player to be a certain rating level with SETUP MENU on TV screen. If the rating level set in the disc is higher than one set in the DVD player, the DVD player can not playback the disc. Sometimes the Parental Control sequences in some discs are different from each other. The rating level setup can be protected by the password. Therein, if you select Unlock item, the Parental Control function will be invalid, the content of disc will be played totally.

The disc movie can be designed as that the DVD player will playback the different version of content of a same movie according to the different rating level set by Parental Control. Depend on the DVD feature of seamless switching described above, the scenes that are not fitting for children will be cleared or replaced by the other fitting scene automatically.

All rating levels of Parental Control are as follows:

	Unlock
1	Kid Safe
2	G
3	PG
4	PG 13
5	PG R
6	R
7	NC 17
8	Adult

4.24.6 DIGITAL SETUP

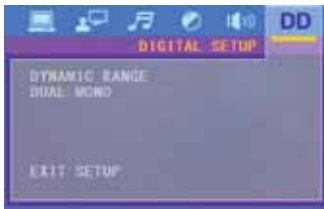

DYNAMIC RANGE

After selecting the compression mode of LINE OUT, set the item, so you can adjust the linear compression ratio. If you set it to be FULL, the Peak-to-Peak value of the audio signal is the minimum; if you set it to be OFF, the Peak-to-Peak value is the maximum.

DUAL MONO

It is for selecting a desired audio output mode for the left and right ways of signal. It is mainly for Karaoke of Ac3. There are 4 modes in all as follows: STEREO, MONO L, MONO R, MIX MONO.

1.5 Remote Control Description

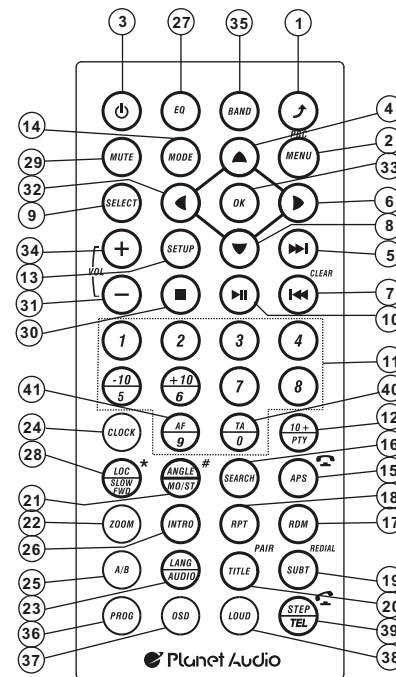

1. BACK BUTTON
2. MENU/PBC BUTTON
3. POWER BUTTON
4. ^ BUTTON
5. >>| BUTTON
6. > BUTTON
7. |<</CLEAR BUTTON
8. v BUTTON
9. SEL BUTTON
10. PLAY/PAUSE BUTTON
11. NUMBER(0~9,+10-10) BUTTONS
12. 10+/PTY BUTTON
13. SETUP BUTTON
14. MODE BUTTON
15. APS/HANGUP BUTTON
29. MUTE BUTTON
30. STOP BUTTON
31. VOLUME- BUTTON
32. < BUTTON
33. OK BUTTON
34. VOLUME+ BUTTON
35. BAND BUTTON
36. PROG BUTTON
37. OSD BUTTON
38. LOUD BUTTON
39. TEL/STEP BUTTON
40. TA BUTTON
41. AF BUTTON

16. SEARCH BUTTON
17. RDM BUTTON
18. RPT BUTTON
19. SUBTITLE/REDIAL BUTTON
20. TITLE/PAIR BUTTON
21. ANGLE/ST/# BUTTON
22. ZOOM BUTTON
23. AUDIO BUTTON
24. CLK BUTTON
25. A-B BUTTON
26. INT BUTTON
27. EQ BUTTON
28. LOC/SLOW-FWD/* BUTTON

1.6 Locations and Names of Controls

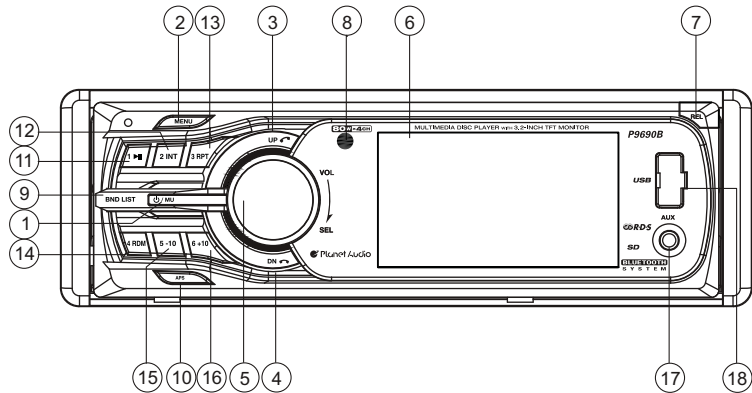

The figure of front panel

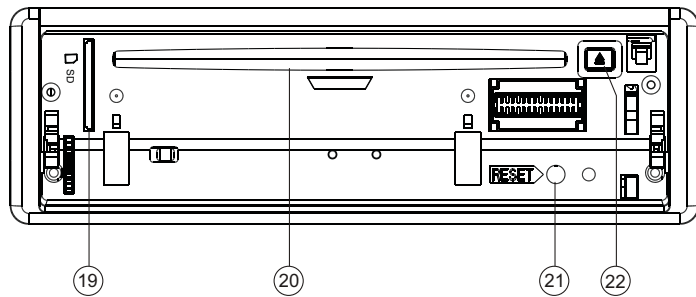

The figure of the Unit Chassis Facet After removing the Front Panel

- | | | |
|------------------------|-------------------------|------------------|
| 1. POWER & MUTE BUTTON | 9. BAND/LIST BUTTON | 17. AUX IN JACK |
| 2. MENU BUTTONS | 10. APS BUTTON | 18. USB JACK |
| 3. UP/TEL BUTTON | 11. 1/PLAY/PAUSE BUTTON | 19. Card slot |
| 4. DOWN/HAND UP BUTTON | 12. 2/INT BUTTON | 20. DISC slot |
| 5. SEL & VOL BUTTON | 13. 3/RPT BUTTON | 21. RESET BUTTON |
| 6. LCD | 14. 4/RDM BUTTON | 22. EJECT BUTTON |
| 7. REL BUTTON | 15. 5/-10 BUTTON | |
| 8. IR SENSOR | 16. 6/+10 BUTTON | |

4.24.4 VIDEO SETUP



BRIGHTNESS

It is for adjusting the brightness of the video output.

CONTRAST

It is for adjusting the contrast of the video output.

HUE

It is for adjusting the hue of the video output.

SATURATION

It is for adjusting the saturation of the video output.

SHARPNESS

It is for adjusting the sharpness of the video output.

4.24.5 SPEAKER SETUP



DOWNMIX

It is for selecting your desired sound effect when there is no center speaker and subwoofer. There are 3 modes: LT/RT, STEREO, VSS.

LT/RT: When playing a disc with PRO LOGIC Dolby stereo effect, choose the item, so it will output audio signal with vivid theatre effect.

STEREO: If you choose the item, when outputting audio signal with 5.1 channels, it will output the left and right channels of signal; when outputting audio signal with 2 channels, it will output the common 2 channels of stereo signal.

VSS: If you choose the item, when playing a disc recorded with 5.1 channels, the main channel speakers can output audio signal with VSS effect.

- Select the RATING item and then press the > button to enter it, then use the direction buttons to select your desired rating level, then press the OK button to confirm.
- Select the PASSWORD item again and then press the > button to enter it, then input the password, and then press the OK button to lock the new setting of the rating level of the Parental Control.

DEFAULT

This item is for making all setup items change back to original status.

4.24.2 LANGUAGE SETUP



OSD LANGUAGE

This item is for selecting the language of the SYSTEM MENU and all operating prompt interface displayed during playback.

AUDIO LANG

This item is for selecting a audio language.

SUBTITLE LANG

This item is for selecting a subtitle language.

MENU LANG

This item is for selecting a disc menu language.

4.24.3 AUDIO SETUP

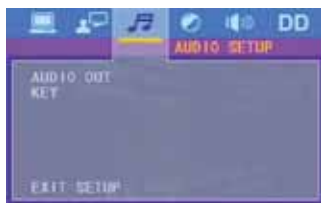

AUDIO OUT

there is only ANALOG mode, i.e. SPDIF/OFF, not optional.

KEY

It is for selecting your desired basic music tone (from low to high).

1.7 Description of the Rear Cabinet

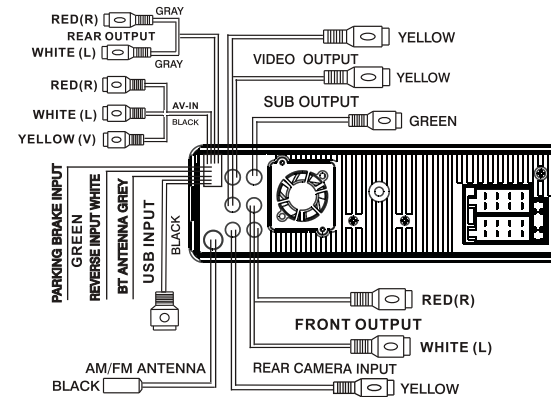

- Note: 1. Parking wire must be connected, and the parking brake must be engaged in order for the monitor to work
2. Use the clip end of the Ground wire provided by manufacturer to connect Mounting Screw, use the other end of the Ground wire to connect the negative pole of the power source. Otherwise, the video on screen may have interference.

Connecting the parking brake line to the parking brake system built in the car

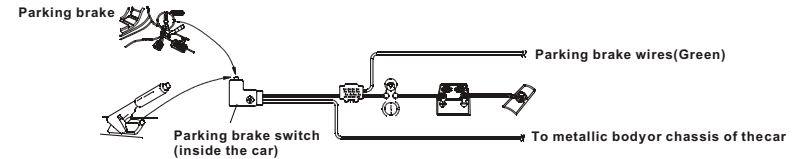

Rear View Camera

In any mode, the video signal will switch to camera mode (if applicable) when car is in reverse. After taking the car out of reverse, it will resume to its previous mode.



Analog on-site backup



Analog on-site backup

Warning:
Always check the surrounding environment. Objects might be reversed. The rear view camera is designed only to assist while reversing. Due to the limitations of the camera angle and range, it may cause accidents if the driver relies solely on the reverse camera and display.

The Description of the Fixed ISO Female Connector

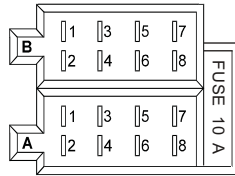

CONNECTOR A

- 1.
- 2.
- 3.
4. Memory +12V(yellow)
5. Auto Antenna(blue)
- 6.
7. 12V (To Ignition Key)(red)
8. GROUND(black)

CONNECTOR B

1. Rear Right Speaker (+)
2. Rear Right Speaker (-)
3. Front Right Speaker (+)
4. Front Right Speaker (-)
5. Front Left Speaker (+)
6. Front Left Speaker (-)
7. Rear Left Speaker (+)
8. Rear Left Speaker (-)

1.8 UNIT INSTALLATION

INSTALLATION INSTRUCTIONS

THE UNIT INSTALLATION IS ANTI-THEFT ONE. THE UNIT CHASSIS WEARS A SLIDING METAL HOUSING. FIRSTLY CONNECT THE POWER LINES, SPEAKER LINES AND AUTO ANTENNA ACCORDING TO MANUAL REQUIREMENT, THEN INSTALL THE SLIDING METAL HOUSING IN A CAR ACCORDING TO THE DIAGRAM.

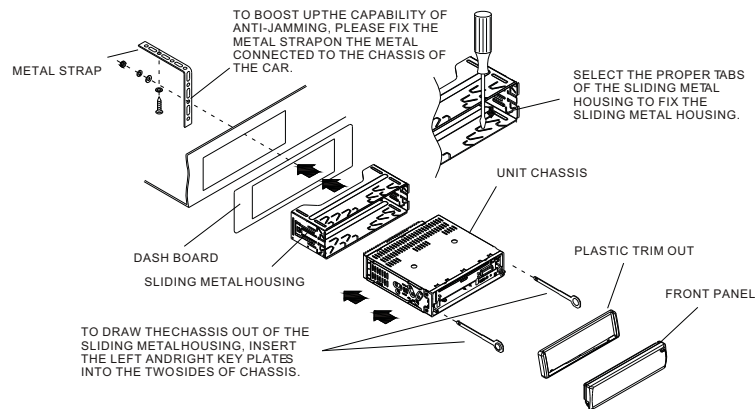

NOTE

REMOVE THE SLIDING METAL HOUSING

REMOVE THE DECK TRANSPORT SCREWS BEFORE INSTALLING IT.

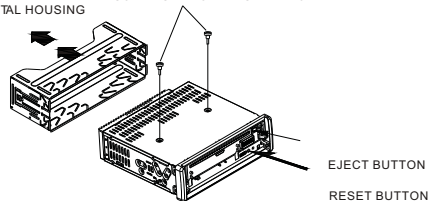

4.24 DVD System Menu Setup Operation

1. Press the SETUP button on the remote controller to access the DVD System Menu on the monitor.
 2. There are 6 setup pages in all for the System Menu. Press the > or < button to select an desired setup page.
 3. Press the ^ or v button to select an setup item in the selected setup page.
 4. Press the > button to enter the setup item. Then press the v or ^ button to select a desired mode of the setup item, finally press the OK button to confirm it.
- * Press the < button to return to the upper level.
- * Press the SETUP button again or use the direction buttons to highlight the item of the EXIT SETUP and then press the OK button to exit the System Menu.

For the DVD System Menu, there are 6 setup pages in all. They display as follows:

4.24.1 SYSTEM SETUP

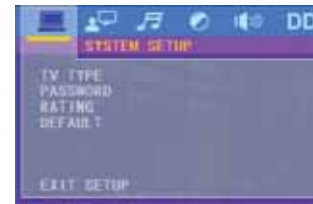

TV TYPE

The setup item is for matching TV screen size.

4:3 PS: Choose the item when connecting a TV set with 4:3 screen. When playing the pictures with 16:9 size, the left and right parts of the video will be cut out, and display in full screen.

4:3 LB: Choose the item when connecting a TV set with 4:3 screen. When playing the pictures with 16:9 size, the top and bottom parts of the TV screen will be turned into a black square respectively.

16:9: Choose the item when connecting a TV set with 16:9 wide screen.

PASSWORD

This setup item is for locking or unlocking the rating level of the Parental Control. The defaulted state is locked. The defaulted password is 0000.

You can set a new password that you like: Select the PASSWORD item and then press the > button to enter it, then input the original password 0000, and then press the OK button to unlock it. Press the > button to enter it again, then input a new password that you like and then press the OK button to make it effective. Before the other persons see the Manual, you should get the password in mind and cut out the part of PASSWORD in the Manual.

RATING

The item is for setting a new rating level of the Parental Control.

1. Select the PASSWORD item and then press the > button to enter it, then input the password mentioned above, and then press the OK button to unlock the setting of the rating level of the Parental Control.

When you select a JPEG file sort icon, press the ^ or > button to select the first JPEG file, then press the v button to select the desired JPEG file, finally press the OK or PLAY/PAUSE button to display the JPEG picture in full screen from the selected JPEG picture.

3. During JPEG playback, press one of the >/</^/v buttons to change the angle of viewing picture that is displaying as follows:
 >: 90 deg cw; <: 90deg ccw; ^: UP<-->DOWN; v: LEFT<-->RIGHT
 During JPEG playback, press the PROG button to change the mode of refresh picture.
 During JPEG playback, press the STOP button to stop playing and return to the root menu.
- * During JPEG playback, the following buttons are not available: SLOW-FWD, SUBTITLE, TITLE, ANGLE, STEP, AUDIO, RDM, INT and A-B.
- * In JPEG mode, the other operations are same as ones in MP3/WMA mode.

4.21 Operation about file style of video

1. The root menu is displayed on TV when beginning to switch on DISC mode, then it will automatically play the first file.
 During playback, press the STOP button to stop playing and return to the root menu.
2. When displaying the root menu, press the direction buttons to select your desired FOLDER or file, then press the OK or PLAY button to open the FOLDER, or play the selected file.
 When displaying the root menu, you can also use the number buttons to select the serial number of the file and play the file.
- * The ANGLE, PROG, RDM, INT and TITLE/PBC button are not valid.
- * The other functions are same as ones in DVD disc; but the RPT function is same as one in MP3/WMA.

4.22 ESP and ID3 Function

There is ESP function for all formats of discs.

In MP3/WMA mode, during playback, the information of the file name, folder name, song s title, artist and album will be scrolling on the LCD display. As long as the current playing MP3 music contains relevant ID3 tag information in version 1.0/2.0 format, the 3 items underlined above will be scrolling on the LCD display; otherwise, they will not.

4.23 USB and SD Reader Operation

Power on the DVD player, then insert the USB storage or SD Card (firstly flip down the front panel), and then the monitor will display the root menu of the USB storage or SD Card.

All the operations are same as ones of the corresponding format.

When you want to pull out the Card, firstly push it, and then pull it out.

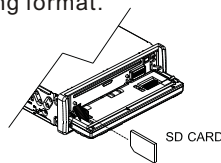

2. Common Operation

1. To turn on/off the unit
 Under power off mode, press the POWER button to turn on the unit.
 Under power on mode, press and hold the POWER button on the front panel or briefly press the POWER button on the remote controller to turn off the unit.
2. To select function mode
 Press the MENU button to turn to mode select, then rotate VOL knob to select TUNER, DISC (After inserting a disc), USB (After inserting a USB storage), Card (After inserting a SD card), AUX or BLUETOOTH mode.
 After selecting, press SEL to confirm and turn to your selection.

Note: This unit has front and rear USB. Only one will work at a time.

3. To adjust sound level
 Rotate the VOL knob on the front panel or press the + or - button on the remote controller to directly adjust the volume level.
4. To mute sound
 Press the MUTE button on the remote controller to turn on/off MUTE mode.
 Briefly pressing the POWER button on the front panel also can turn on/off MUTE mode.
 In MUTE mode, the MUTE mode can be released by pressing the following buttons: MUTE, VOL or +/-, SEL, MODE.
5. To display and adjust the clock time
 Press the CLK button to display clock time on the monitor of the front panel.
 To adjust the time, please turn to setup mode time setting.
6. To select a preset EQ mode
 Press the EQ button to select the preset music equalizer curves: POP, ROCK, CLAS, EQ OFF. The sound effect will be changed.
7. To remove the front panel
 Press the REL button on the front panel to detach the front panel from the unit, then you can remove the front panel.
8. To turn on/off LOUDNESS mode
 Press the LOUD button to turn on/off LOUDNESS mode.
 When turning on LOUDNESS mode, it will enhance bass level immediately when the bass is not enough.
9. To reset the unit
 when the display is incorrect, or the function buttons are not effective or sound is distorted, press the REL button to detach the front panel from the unit and remove it, then use a small point to press the RESET button, which will reset to factory default, and re-instate the correct functions.

10. To adjust sound modes

To adjust the sound modes, briefly and repeatedly press the SEL button on the front panel to select one of the sound modes such as : VOL, BAS (without preset EQ), TRE (without preset EQ), BAL, FAD and EQ.

Note: this function except in play mode select.

11. Return control

Press the  button or MENU button to up to the previous menu.

12. To do setup

In setup mode, select the GENERAL, CLOCK, OSD LANGUAGE, AUDIO, VIDEO, RADIO as follow:

GENERAL SETUP

Logo: this function allows to choose the starting screen.

Beep: choose the buttons' sound on/off.

CLOCK SETUP

Clock mode: select 24 HOUR or 12 HOUR.

Clock time: adjust the clock.

LANGUAGE SETUP

OSD Language: only be English.

AUDIO SETUP

MBP: choose between MBP LEFT/RIGHT/OFF.

Loud: choose between Loudness ON/OFF.

EQ: choose between the different types of EQ.

VIDEO SETUP

Brightness

Contrast

Saturation

Hue

RADIO SETUP

Radio region: choose the radio zone.

RDS setting: ON/OFF



GENERAL SETUP



CLOCK SETUP



LANGUAGE SETUP



AUDIO SETUP



VIDEO SETUP



RADIO SETUP

4.19 Program Playback

It allows you to enter the order in which you want some chapters/tracks in DVD/VCD/MP3/WMA/CD disc to play.

- 1 During playback, press the PROG button to enter a program interface as follows:

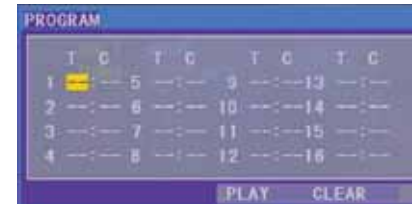

- 2 Use the direction buttons to move cursor onto the desired place for inputting the sequence number.
- 3 Use the number button to input desired sequence number of title/chapter/track with desired sequence.
- 4 Use the direction button to move cursor onto Play item, then press the OK button to play the programmed titles/chapters/tracks in programmed order; only pressing the PLAY button also can play the programmed titles/chapters/tracks in programmed order.
 - * To exit program playback, firstly press the STOP button, then press the PLAY button to enter sequence playback; or press the PROG button twice again.
 - * To remove the all programmed sequence numbers, move the cursor onto Clear item, then press the OK button.
 - * To change the programmed sequence, move the cursor onto the item you want to change, input the desired sequence number.
 - * During VCD playback, if it is in PBC ON mode, at the same time of entering the state of program playback, it turns off PBC mode.

4.20 Playback Picture CD in JPEG Format

1. The root menu is displayed on the monitor when beginning to switch on DISC mode. At the time, it plays MP3/WMA file. (the TITLE or MENU button is not available).
In the root menu, the left file sort icon is for MP3/WMA file; the middle file sort icon is for JPEG file; the right file sort icon is for VIDEO file. If one of these 3 file sort does not exist, you can not move cursor onto the file sort icon.
2. When displaying the root menu, press the direction buttons to select your desired FOLDER, file or file sort icon, then press the OK or PLAY button to open the FOLDER, or play the selected file, or play only this sort of file. When displaying the root menu, you can also use the number buttons to select the serial number of the file and play the file.

4.14 Playback in Random

When playing DVD/VCD(PBC OFF)/MP3/WMA/CD discs, press the RDM button to switch between RANDOM (ON)/RANDOM OFF. When in RANDOM (ON) mode, it will play in random.

4.15 Playback in Different Angle

1. When playing VCD/MP3/WMA/CD discs, the ANGLE button on the IR remote control is not available.
2. When playing DVD discs, press the ANGLE button repeatedly on the IR remote control to view in different angle. (This function is only for the DVD discs with ANGLE function)

4.16 Playback in Zoom Mode

In DVD/VCD mode, during playback, press the ZOOM button continuously to enlarge a certain area of the images on the screen with these multiples:

ZOOMx2, ZOOMx3, ZOOMx4, ZOOMx1/2, ZOOMx1/3, ZOOMx1/4, ZOOM OFF.
Press one of the \wedge / \vee / $\>$ / $\<$ buttons to select the area you want to enlarge.

4.17 Change Caption Language

When playing DVD discs, press the SUBTITLE button repeatedly to select the language of the caption or turn off the caption. (depend on the disc used.)

When playing VCD/MP3/WMA/CD discs, the button is not available.

4.18 Change Audio Language

1. When playing DVD discs, press the AUDIO button repeatedly on the IR remote control to select the desired language type (depend on the disc used)
2. When playing VCD discs, press the AUDIO button repeatedly to select the sound mode of the MONO L, MONO R, and Stereo, no language function.
3. When playing CD/WMA/MP3 discs, the AUDIO button is invalid.

3. Radio Operation

1. BAND BUTTON

Press the BAND button on the front panel to select your desired radio band of FM1, FM2, FM3, AM1 and AM2, and the selected band will be displayed on the monitor of the front panel, press 1-6 buttons to select your favour.

Press and hold this button again to select RDS function such as : PTY, AF, TA, ST, LOC, LOUD by rotate VOL knob.



Radio interface-1

2. TUNE/SEEK UP/DOWN BUTTONS

- 1) Press and hold the UP/ DN button to automatically search up/down for a available station from the current frequency.
- 2) Briefly press the UP / DN button to manually search up or down with step by step for your desired station from the current frequency.



Radio interface-2

3. APS BUTTON

- 1) When pressing and holding the APS button, the radio searches from the lowest frequency and checks the signal strength level until 1 cycle search is finished. And then the 6 strongest stations are preset to the corresponding preset number memory bank. The AS operation is implemented in each bank of the selected band. When the AS operation is finished, the radio executes the preset scan, and after preset scanning for one cycle, it will stop scanning and broadcasting the No.1 station for Fm1. (It can store 3x6 stations for FM and 2x6 stations for AM in all)
- 2) When pressing the APS button briefly on the front panel or the remote control, the radio searches for each preset station from the M1. When the field strength level is more than the threshold level of the stop level, the radio holds at that preset number for few seconds with releasing mute, and then searches again. After finishing a circle of searching, it will stop searching on the M1.

NOTE: In FM band, FM1, FM2, FM3 is checked one at a time.
In AM band, AM1, AM2 is checked one at a time.

4. PRESET STATION [1-6] BUTTONS

- 1) To memorize the current frequency on the current band, press and hold any one of the six Number buttons (1-6) .
- 2) To recall the memory station on the current band, press one of the Number buttons [1-6] .

5. STEREO/MONO BUTTON

Press the ST button on the remote control to select the STEREO or MONO sound mode for FM band.

6. LOC BUTTON

- 1) When the signal of distant radio stations are very weak and the receiving effect is bad during tuning, check whether there is the word LOC on LCD. If there is the word LOC on LCD, press this button to turn off the LOC function, then tune again for the distance radio station;
- 2) When the signals from the local radio stations are too strong, this could lead to interference. press this button to turn on the LOC function, and the LOC icon will be lit up on the LCD. Re-tune for the local station required.

7. PTY (PROGRAM TYPE) BUTTON

Press the PTY button briefly to select one of the following modes:

PTY MUSIC group- - PTYSPEECH group- - PTY OFF

When PTY group is on, press the VOL+ or VOL- button on the remote controller or rotate the VOL knob on the front panel to select one of PTY programs: <-->NEWS<-->AFFAIRS<-->INFO<-->SPORT<-->EDUCATE<-->DRAMA<-->CULTURE<-->SCIENCE<-->VARIED<-->WEATHER<-->FINANCE<-->CHILDREN<-->SOCIAL<-->RELIGION<-->PHONE IN<-->TRAVEL<-->LEISURE<-->DOCUMENT<-->PTY NONE<-->POP M<-->ROCK M<-->EASY M<-->LIGHT M<-->CLASSICS<-->OTHER M<-->JAZZ<-->COUNTRY<-->NATION M<-->OLDIES<-->FOLK M<-->

When PTY group is on, pressing the 6 number buttons also can select one of PTY programs as above.

After selecting one of the PTY programs, it will display SEEK PTY and automatically search for the station of the PTY program. If the station of the PTY program does not exist, it will display PTYNONE and then return back to the normal station.

8. AF [ALTERNATIVE FREQUENCIES] BUTTON

When pressing the AF button briefly, the AF switching mode is selected and the state of the AF switching mode is displayed by AF segment in display.

Segment off: AF switching mode off.

Segment on: AF switching mode on, and has RDS information.

Segment flashing: AF switching mode on, but RDS information is not received yet.

When the AF switching mode is selected, the radio checks the signal strength of the AF all the time. The interval of checking time of each AFs depends on the signal strength of the current station, from a few minute for the strong station to a few seconds for the weak station. Every time that a new AF is stronger than the current station, it switches over to that frequency for very short time, and the NEWFREQUENCY is displayed for 1-2 second. Because the mute time of the AF switching or the checking time is very short, it is almost inaudible in case of normal program. (When AF flash on LCD, it will search for the stronger RDS station. If AF and TP flash on LCD, it can only search for the traffic announcement station).

In FM mode, when AF is on, SEEK, (SCAN), AUTO-MEMORY function can only receive and save the RDS program.

9. TA [TRAFFIC ANNOUNCEMENT] BUTTON

Press the TA button briefly to turn on TA search mode.

When traffic announcement is transmitted:

- 1). If the unit is in Disc Play mode, it will switch to radio mode temporarily.
- 2). Temporarily switch over to an EON linked station when EON detects a traffic announcement on that other program, and TA, TP will be displayed on LCD

* TA interruption function:

The current traffic announcement is cancelled by pressing TA button briefly.

* When TA is on, SEEK, (SCAN), AUTOMEMORY function can be received or saved only when traffic program identification code has been received.

4.11.2 A-B Repeat

Press the **A-B** button if you want to repeat a specific segment on a disc that you define:

1. Press the **A-B** button at a point (A) where you want it to be the start point of the repeat segment. Press the **A-B** button again at a point (B) where you want it to be the terminal point of the repeat segment. Then it will play the segment repeatedly.
2. To cancel the A-B repeat mode and resume normal playback, press the **A-B** button for the third time.

Note:

During VCD/MP3/WMA/CD playback, points A and B must be within the same track.

During DVD playback, points A and B can be selected from different chapters.

4.12 Playback in Scan Mode

1. When playing VCD (PBC OFF)/CD discs, press the INT button to play the previous 10 seconds part of each track on the disc. Press the INT button again to resume normal playback.
2. When playing DVD/MP3/WMA discs, the INT button is not available.

4.13 Playback from a specified chapter/track or a specified time

1. When playing DVD discs, press the SEARCH button to display a interface and highlight the title item, then use the number buttons to input the serial number of the title; use the direction buttons to highlight the chapter item, then use the number buttons to input the serial number of the chapter; you can still use the direction buttons to highlight the time item, then use the number buttons to input the desired time to start playback; finally press the OK or PLAY button to play the selected chapter or play from the selected time.
2. When playing VCD/MP3/WMA/CD discs, press the SEARCH button to display a interface and highlight the track item, then use the number buttons to input the serial number of the track; you can still use the direction buttons to highlight the time item, then use the number buttons to input the desired time to start playback; finally press the OK or PLAY button to play the selected track or play from the selected time.

4.8 Playback with Speed

During normal playback, press and hold the UP/DN button on the front panel or the >>||<< button on the remote controller continuously to fast forwards or backwards at the following speeds: x2, x4, x8, x20, normal.

During speed playback, press the PLAY button to resume normal playback.

4.9 Playback with Slow Speed

During playback, press the SLOW_FWD button to execute the Slow Forward function.

With each consecutive pressing of the SLOW_FWD button, the playback speed decreases. The speed levels in Slow Forward as follows: x1/2, x1/3, x1/4, x1/5, x1/6, x1/7, normal.

During slow forward, press the PLAY button to resume normal playback.

The function is only for video.

4.10 Playback with still frame

If the unit is currently running DVD/VCD disc, press the STEP button consecutively to display the still frame forward with step by step.

Press the PLAY button to resume normal playback.

4.11 Playback Repeatedly

4.11.1 ONE/ALL Repeat

1. In the mode of DVD disc playback:
Press the RPT button to select REP CHAPTER, REP TITLE, REP ALL or REP OFF.
2. In the mode of VCD (PBC OFF)/CD disc playback:
press the RPT button to select REP ONE, REP ALL or OFF.
When it is in the state of PBC ON, during VCD disc playing, the RPT button are not available.
3. In the mode of MP3/WMA disc playback:
Press the RPT button to select REP ONE, REP DIR, REP ALL or OFF.

4. Basic Disc, USB or SD Operation

4.1 Begin playback

1. Press the POWER button briefly to turn on the DVD player.

After turning on the DVD player, please turn on the monitor, and ensure that the video output of the monitor is the video input from the DVD player connected with the monitor.

? Common Question

Q: There is nothing displayed on TV screen when the DVD player is turned on. How to solve the problem?

A: Ensure that the TV is set to correct video input (not TV channel); for example, if you make VIDEO1 INPUT of TV and DVD player connected with each other, then you need set TV to VIDEO1.







2. Press the RELEASE button to detach the front panel from the unit.

3. Insert a disc into the DISC SLOT (Label surface up), then flip up the front panel until it clicks into place.

NOTE

1. For some discs that are seriously scratched or poor manufacturing or recording quality, it may not play.
2. If the player can not read disc under normal condition, please try to eject and reload the disc again.
3. Remark:
 - 1) In addition to normal CD and DVD, this unit supports to play CD-R, CD-R/W, DVD-R and DVD-R/W as well; however, depending on the conditions of the recording equipment, recording program or the disc itself, some CD-R, CD-R/W, DVD-R or DVD-R/W may not play.
 - 2) When dealing with CD-R, CD-R/W, DVD-R or DVD-R/W recording, too high recording speed may result in poor signal quality and therefore, it is recommendable to select as lower as possible recording speed.
4. **Play USB & Card**
Insert an USB or SD Card into their slots respectively, then the root menu will be displayed on the monitor and it will play audio file automatically if the USB or SD Card include audio files.

Press OSD on the remote to turn on function select.

-  :select to pause playback.
-  : select to stop playback .
-  : select either one for next or previous chapter/track.
-  : Same as the REPEAT button on the remote control.
-  : To select RDM on/off.
-  : To select audio language.
-  : To select LOUD on/off.



USB interface



Audio interface-1

4.2 Pause Playback

When playing DVD/VCD/CD/MP3/WMA discs, press the PAUSE button on IR remote control to pause the playback, press the PLAY button to resume normal playback.



Audio interface-2

4.3 Stop Playback

When playing DVD/VCD/MP3/WMA/CD discs, press the STOP button once to pause the playback, then press the PLAY button to resume the normal playback; press the STOP button twice to stop the playback, then press the PLAY button to start playback from the beginning of the first chapter/track.



Keyboard interface

4.4 Select Chapter/Track with UP/DN or >>|/|<< Button

Press the UP/DN button on the front panel or the >>|/|<< button on the remote control during playback to select the next or last chapter/track to playback.

Note: Press the UP/DN or the >>|/|<< button multiple times to advance multiple chapters/tracks forward or backward.

4.5 Select Chapter/Track with Number Buttons

When playing DVD/VCD(PBC OFF)/MP3/WMA/CD discs, press one of the 1~9 number buttons to directly select and play the 1st to 9th track/chapter.

If you want to play the track/chapter with serial number bigger than 9, For example 1, to play the 13th track/chapter, just press 1 and then press 3, you can also press the 10+ button and then press 3; to play the 23th track/chapter, just press 2 and then press 3 or press the 10+ button twice and then press 3.

For example 2, to play the 107 track/chapter, just press 1 and press 0 and then press 7 on the remote.

Note: pressing and holding the +10 or -10 buttons will allow you to play the next 10 or last 10 chapter/track (only for MP3/WMA).

4.6 Select Chapter/Track with Root/PBC Menu (If the used disc includes root/PBC menu)

When playing DVD discs:

1. Press the TITLE button on the remote control to display the title list.
 2. Press the direction buttons to select your desired title, and then press the OK or PLAY button to open the root menu of the selected title.
 3. Press the direction buttons to select your desired chapter, finally press the OK or PLAY button to play the selected chapter.
- During playback, pressing the MENU button can directly display the root menu of the title that is playing.

In VCD mode

1. When starting to turn on the PBC function, it will play from the beginning of the disc till it display the PBC menu on TV screen, if the disc includes PBC menu.
2. Press the number buttons to select your desired track to play.

In MP3/WMA mode

1. The root menu is displayed on the monitor screen all the time (and the TITLE or MENU button is not available).
2. Press the direction buttons to select your desired FOLDER, then press the OK or PLAY button to open the FOLDER, and then press the direction buttons to select your desired file, finally press the OK button to play the selected file.

In CD mode, the TITLE, PBC, MENU buttons are disabled.

4.7 Terminate Playback

1. Press the RELEASE button to detach the front panel from the unit, then press the EJECT button to eject disc, and then remove the disc and flip up the front panel till hearing a clip.

2. Press and hold the POWER button on the front panel or briefly press the POWER button on the remote controller to turn off the DVD player.